

A person stands on a rocky shore, looking out at the ocean under a night sky with a vibrant aurora borealis. The scene is dark and atmospheric, with the aurora displaying shades of green, blue, and purple. The person is silhouetted against the bright light of the aurora.

The Future Begins Here

intel® labs

Labs Day 2020 | December 3

The
Future
Begins
Here

intel labs

In Pursuit of 1000X:

Disruptive Research for the Next
Decade of Computing

Rich Uhlig

Intel Sr. Fellow, VP, & Director of Intel Labs

Labs Day 2020



**“The future is already here.
It’s just not evenly distributed.”**

William Gibson



The Data Problem

We are **generating data** at a **faster** rate than our ability to **analyze, understand, transmit, secure and reconstruct** in real-time



Performance Democratization

Digitize Everything



1980

Network Everything



1990

Mobile Everything



2000

Cloud Everything



2010

2020

100B
INTELLIGENT
CONNECTED
DEVICES

Distributed Intelligence



Compute

10^{18}

10^{15}

10^9

10^4

10^2

Exascale
For Everyone

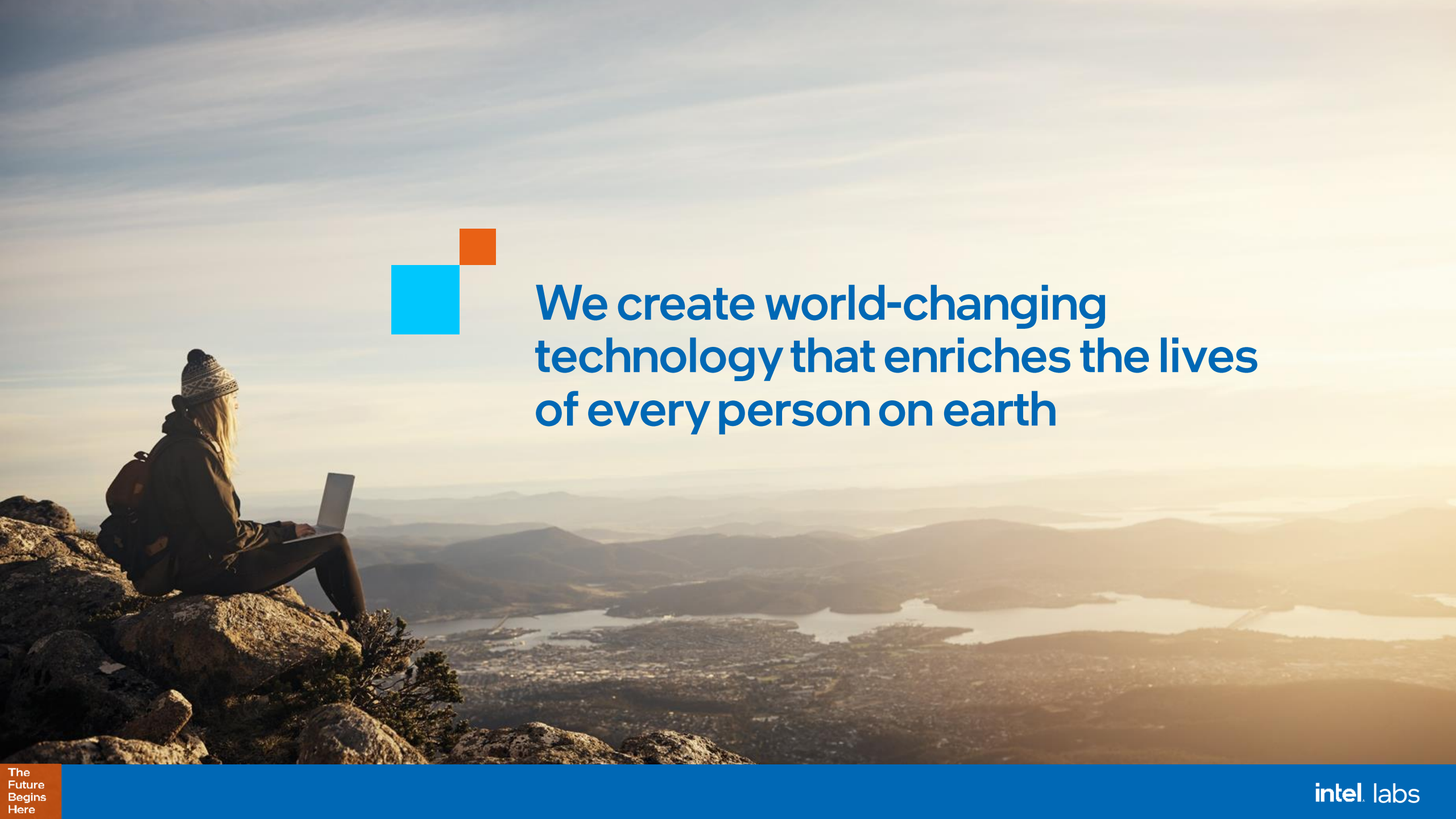

We create world-changing technology that enriches the lives of every person on earth

In Pursuit of
1000X

intel labs

USB & Thunderbolt

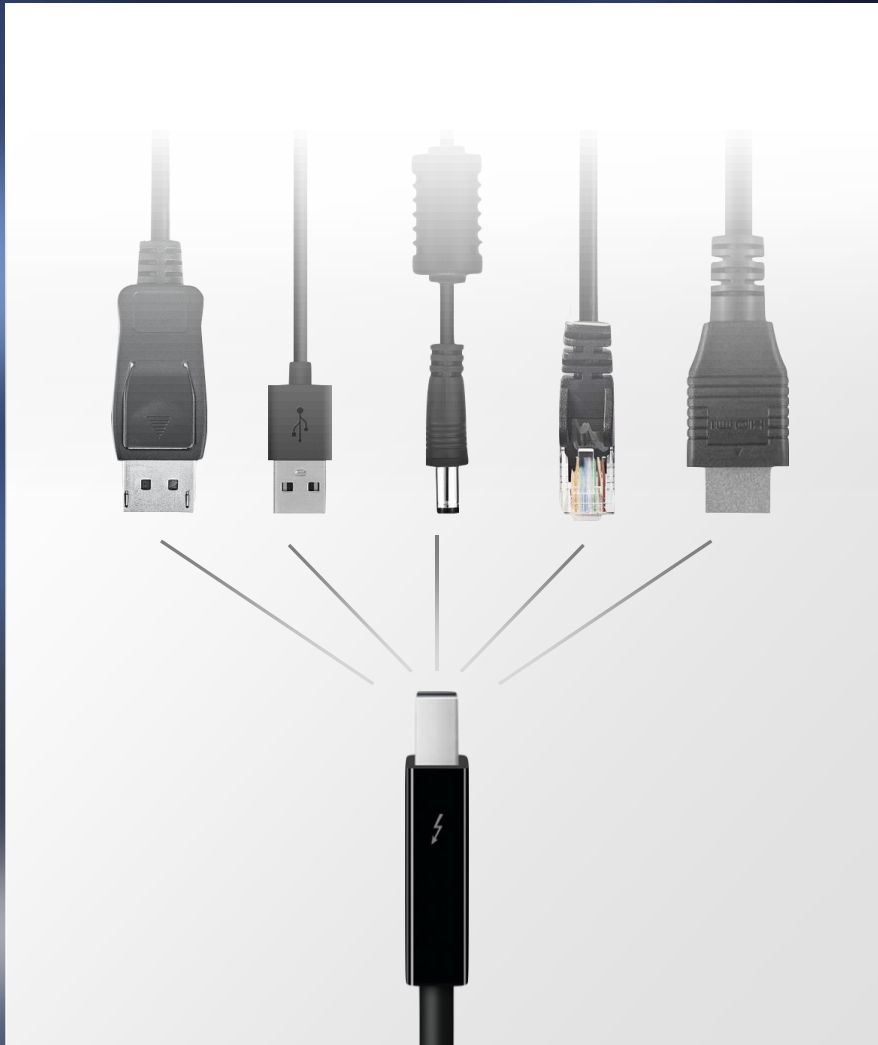

Silicon Photonics

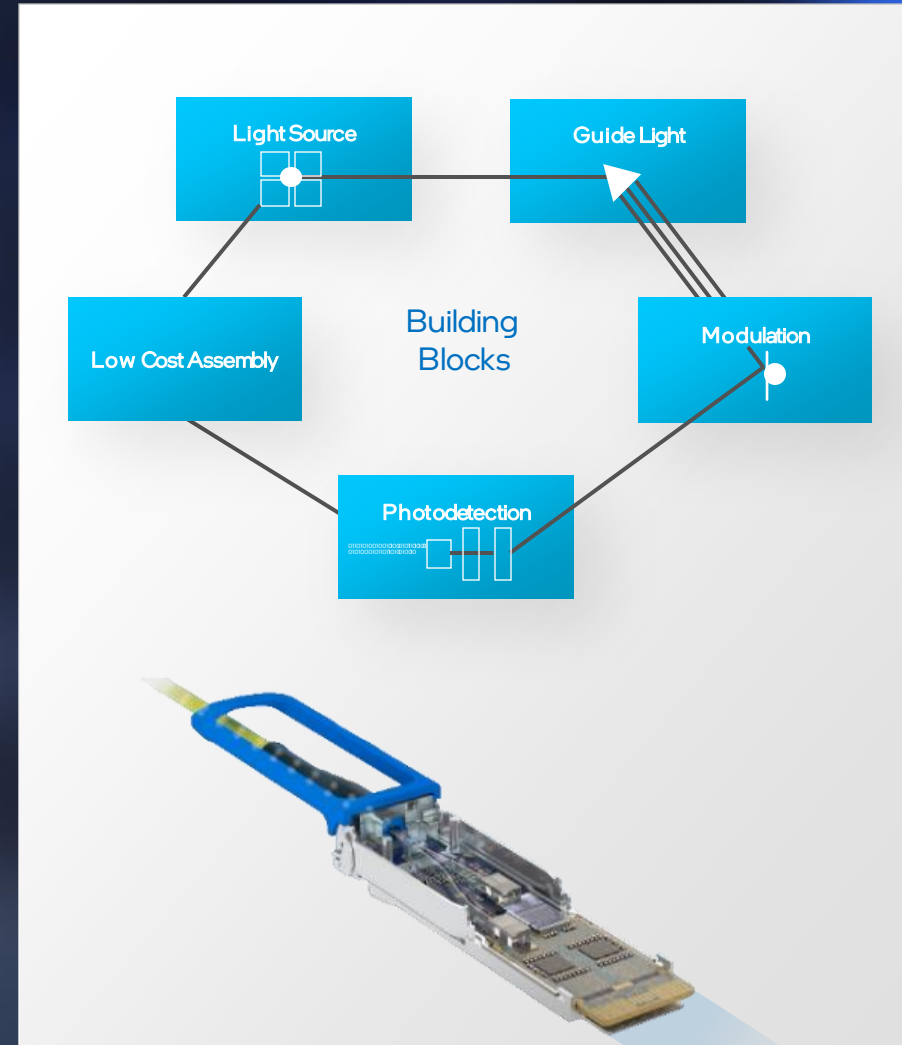



THUNDERBOLT™



Other names and brands may be claimed as the property of others

The
Future
Begins
Here

intel. labs

Today's Tracks

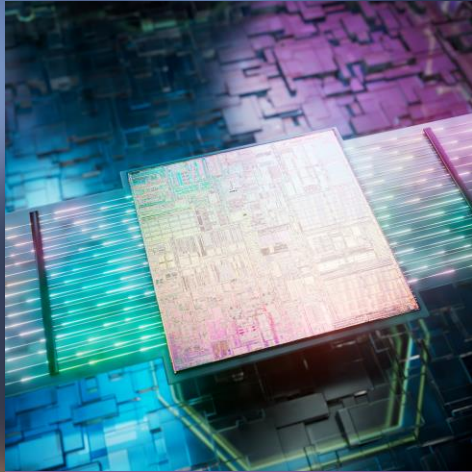

Integrated
Photonics

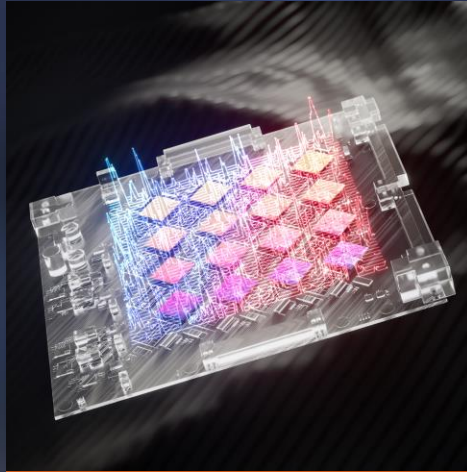

Neuromorphic
Computing

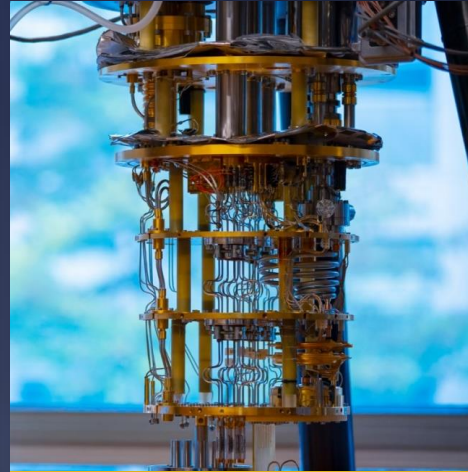

Quantum
Computing



Confidential
Computing



Machine
Programming



Integrated Photonics

intel
labs

The
Future
Begins
Here

intel labs

Attacking the I/O Power Wall

James Jaussi

Senior Principal Engineer and
Director of PHY Research Lab

Labs Day 2020

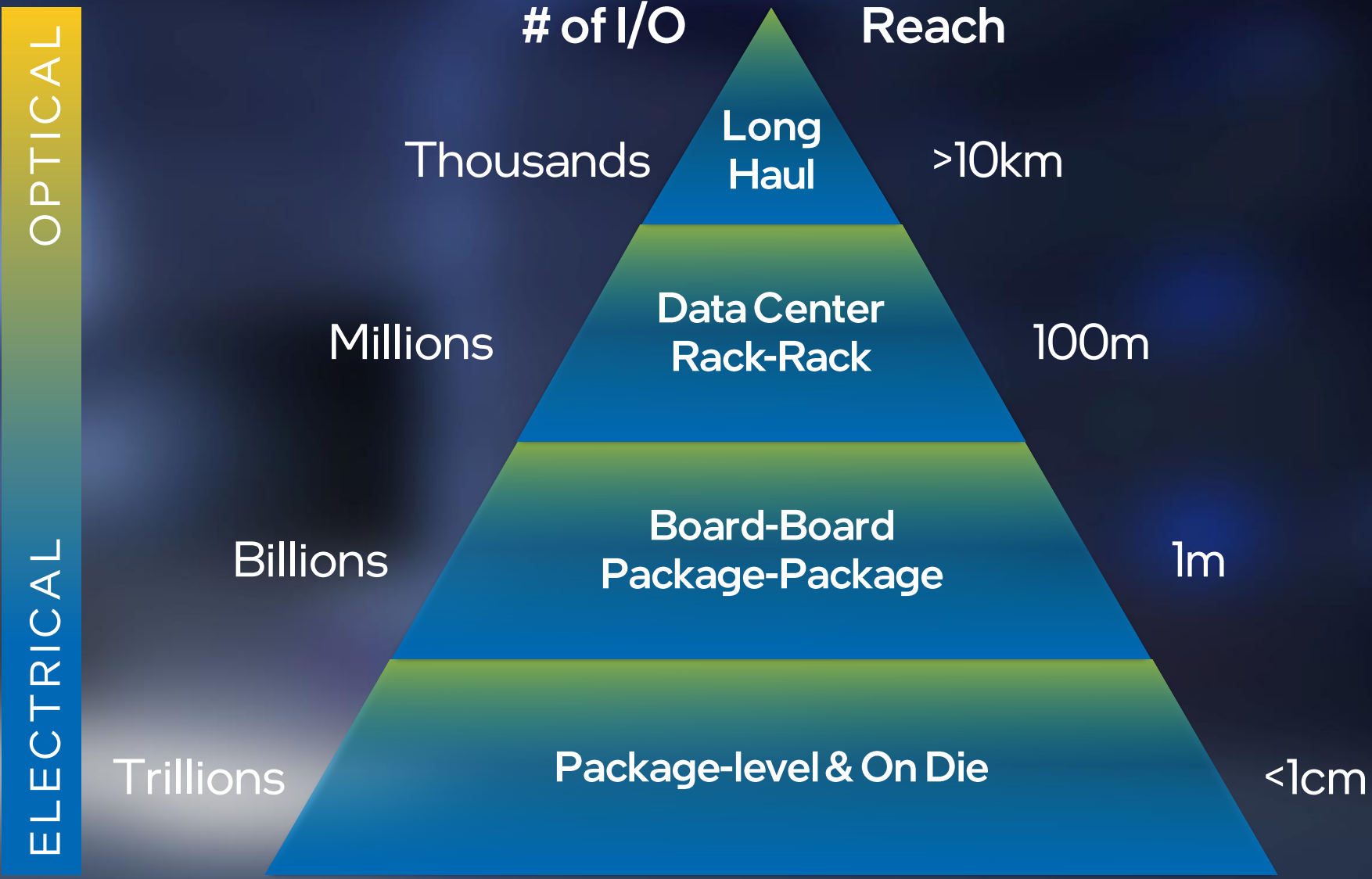

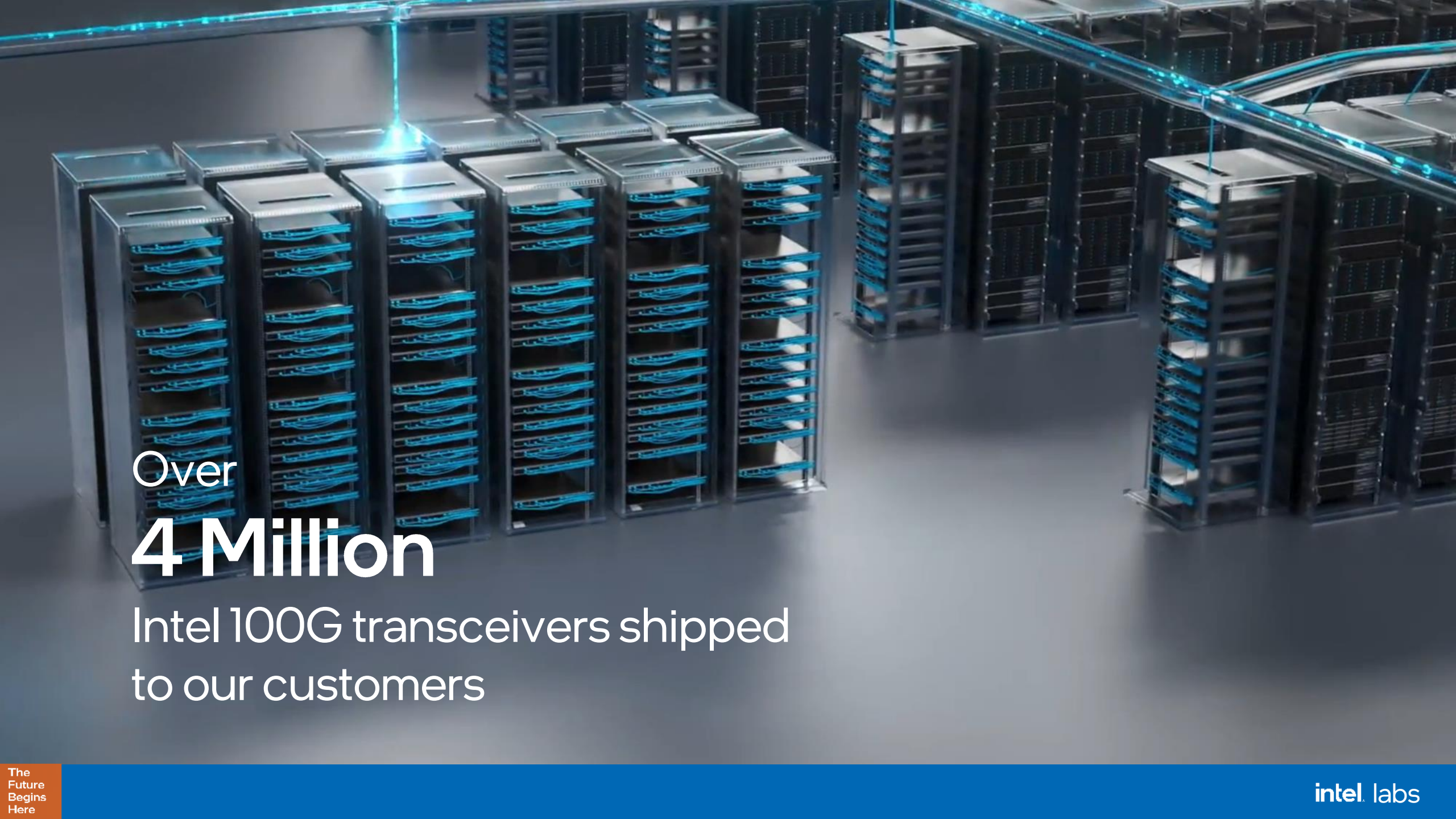

Over

4 Million

Intel 100G transceivers shipped
to our customers

Integrated Photonics
Bringing optical I/O
directly into our servers
and onto our packages





Millions to Billions
1000X



intel
labs

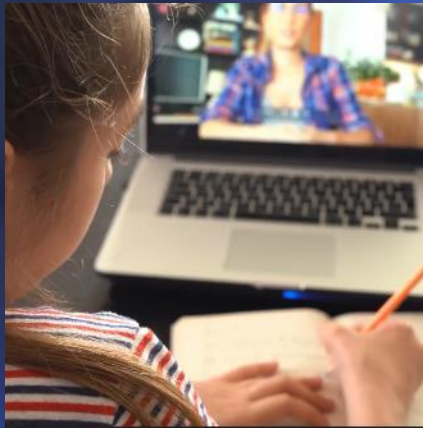

Reach

>10km

100m

1m

<1cm

OPTICAL
ELECTRICAL

Electrical I/O

Theoretical Limit

Practical Limit

Link Performance

Electrical I/O is performance-distance limited

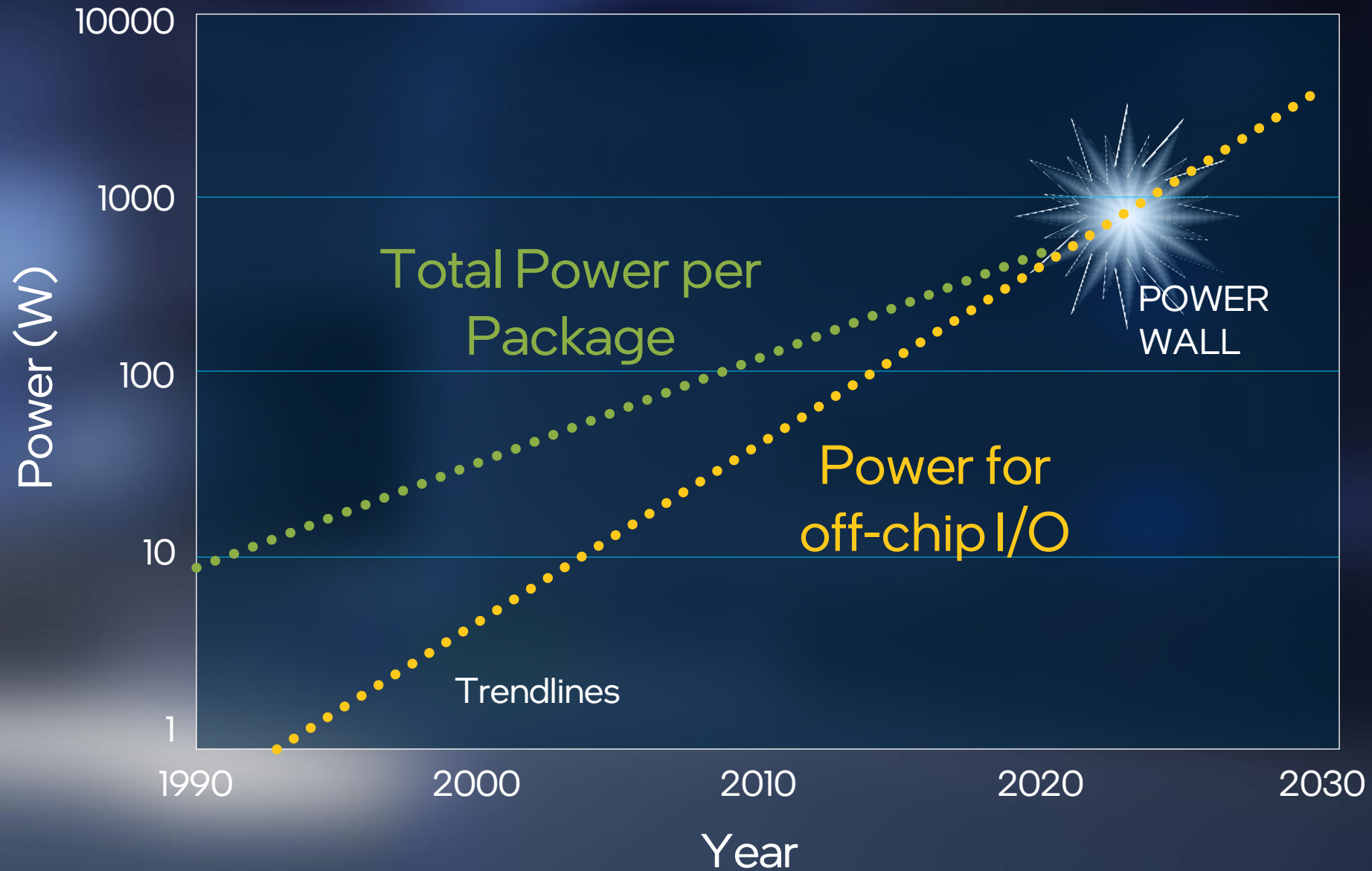

Credit: DARPA for trendlines



Integrated Photonics
will fundamentally
change compute I/O.



intel
labs

Silicon Photonics Building Blocks

Light Source



Modulation
Mux/Demux



Guide/Amplify
Light



Detection



Integrated Photonics

Silicon Photonics
CMOS Electronics
Package Integration

Light Source



Modulation
Mux/Demux



CMOS Circuits

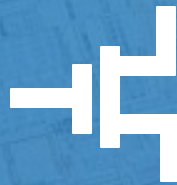

Packaging



Guide/Amplify
Light



Detection

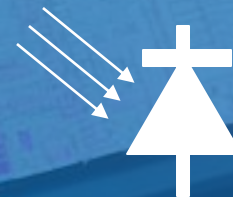

Integrated Photonics Prototype

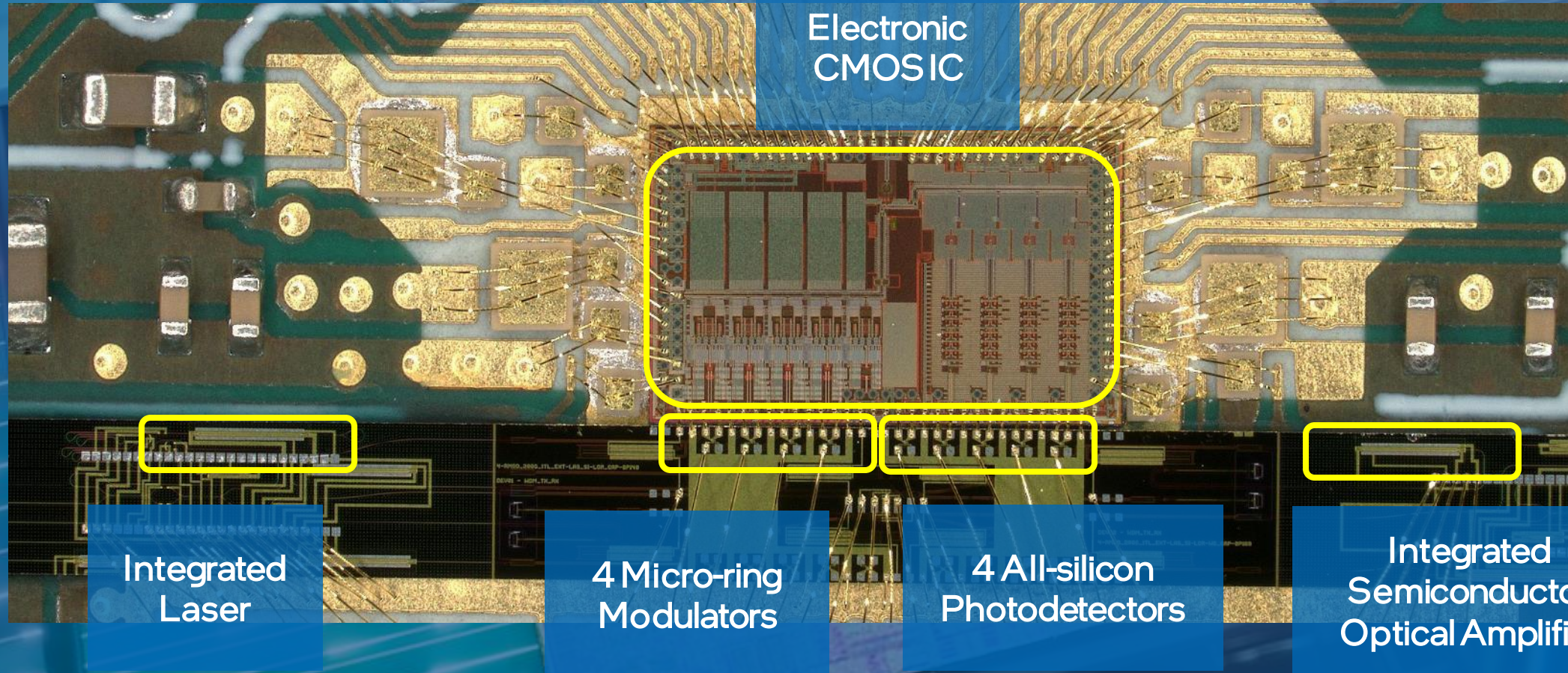

Industry-leading Prototype with Key Technology Building Blocks

Neuromorphic Computing

intel
labs

The
Future
Begins
Here

intel labs

Synapses to Silicon: Brain-inspired Microarchitecture

Mike Davies

Director Of Neuromorphic Computing Research

Labs Day 2020

2018 IROS Drone Racing Competition



Other names and brands may be claimed as the property of others

Brains are Unrivaled Computing Devices

COCKATIEL PARROT

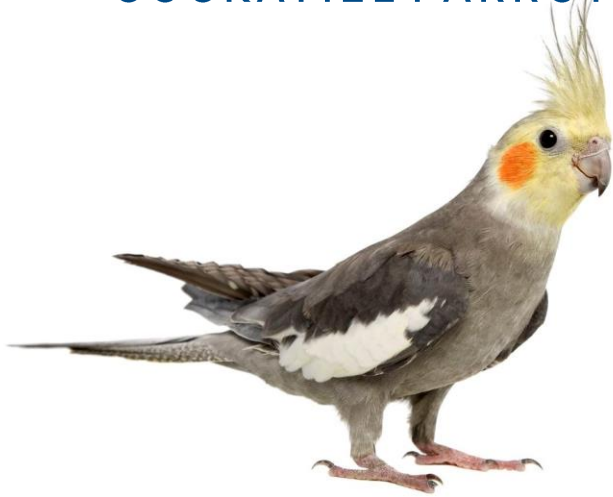

Brain
Power: 50 mW
Mass: 2.2 grams

Navigates and learns
unknown environments
at 22 mph

Can learn to speak
English words

Can learn to
manipulate cups
for drinking

AUTONOMOUS DRONE

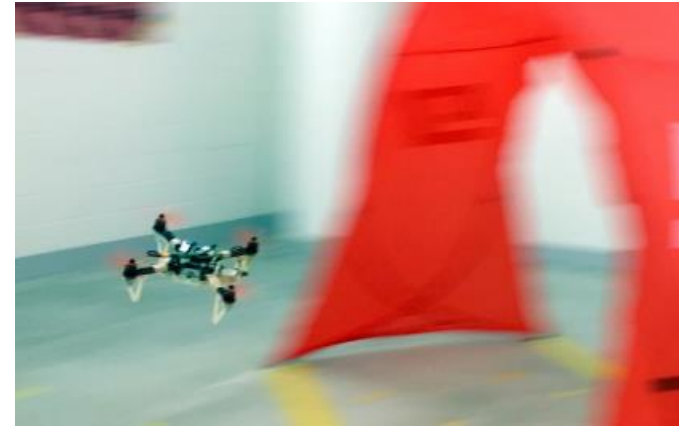

CPU/GPU controller
Power: 18,000 mW
Mass: ~40 grams

Pre-trained to fly
between known
gates at 5.6 mph

Can't learn anything
online

Sources: PNAS, June 13, 2016; <https://link.springer.com/article/10.1007/s00360-011-0603-1>; Davide Scaramuzza, ETH Zurich and A. Loquercio et al, "Deep Drone Racing: From Simulation to Reality with Domain Randomization," IEEE Trans. Robotics, 2020.

A New Kind of Computer Architecture

Standard Computing

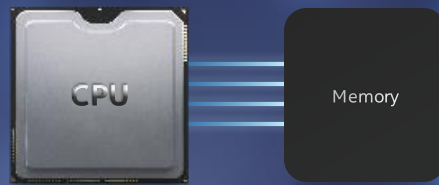

Parallel Computing

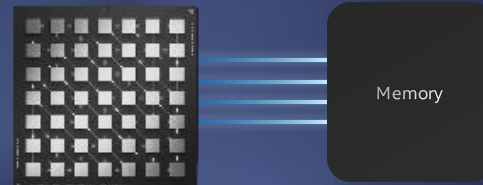

Neuromorphic Computing

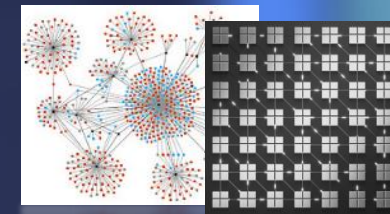

| | | |
|------------------------------------|---|--|
| PROGRAMMING BY ENCODING ALGORITHMS | OFFLINE TRAINING USING LABELED DATASETS | LEARN ON THE FLY THROUGH NEURON FIRING RULES |
| SYNCHRONOUS CLOCKING | SYNCHRONOUS CLOCKING | ASYNCHRONOUS EVENT-BASED SPIKES |
| SEQUENTIAL THREADS OF CONTROL | PARALLEL DENSE COMPUTE | PARALLEL SPARSE COMPUTE |

Loihi

KEY PROPERTIES

- 128k neurons and 128 million synapses
- Compute-memory integrated architecture
- Fully digital in standard 14nm process
- Asynchronous design enables scalability
- Versatile on-chip learning – a first for the field

Yet,

- No floating point numbers!
 - No multiply-accumulators!
- Fundamental to deep learning hardware

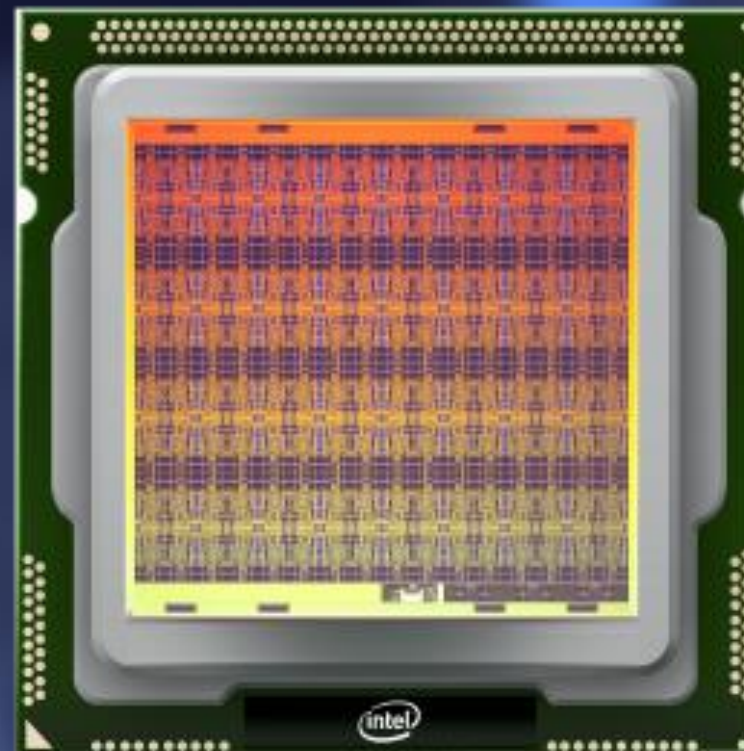

Loihi

KEY PROPERTIES

- 128k neurons and 128 million synapses
- Compute-memory integrated architecture
- Fully digital in standard 14nm process
- Asynchronous design enables scalability
- Versatile on-chip learning – a first for the field

Yet,

- No floating point numbers!
 - No multiply-accumulators!
- Fundamental to deep learning hardware

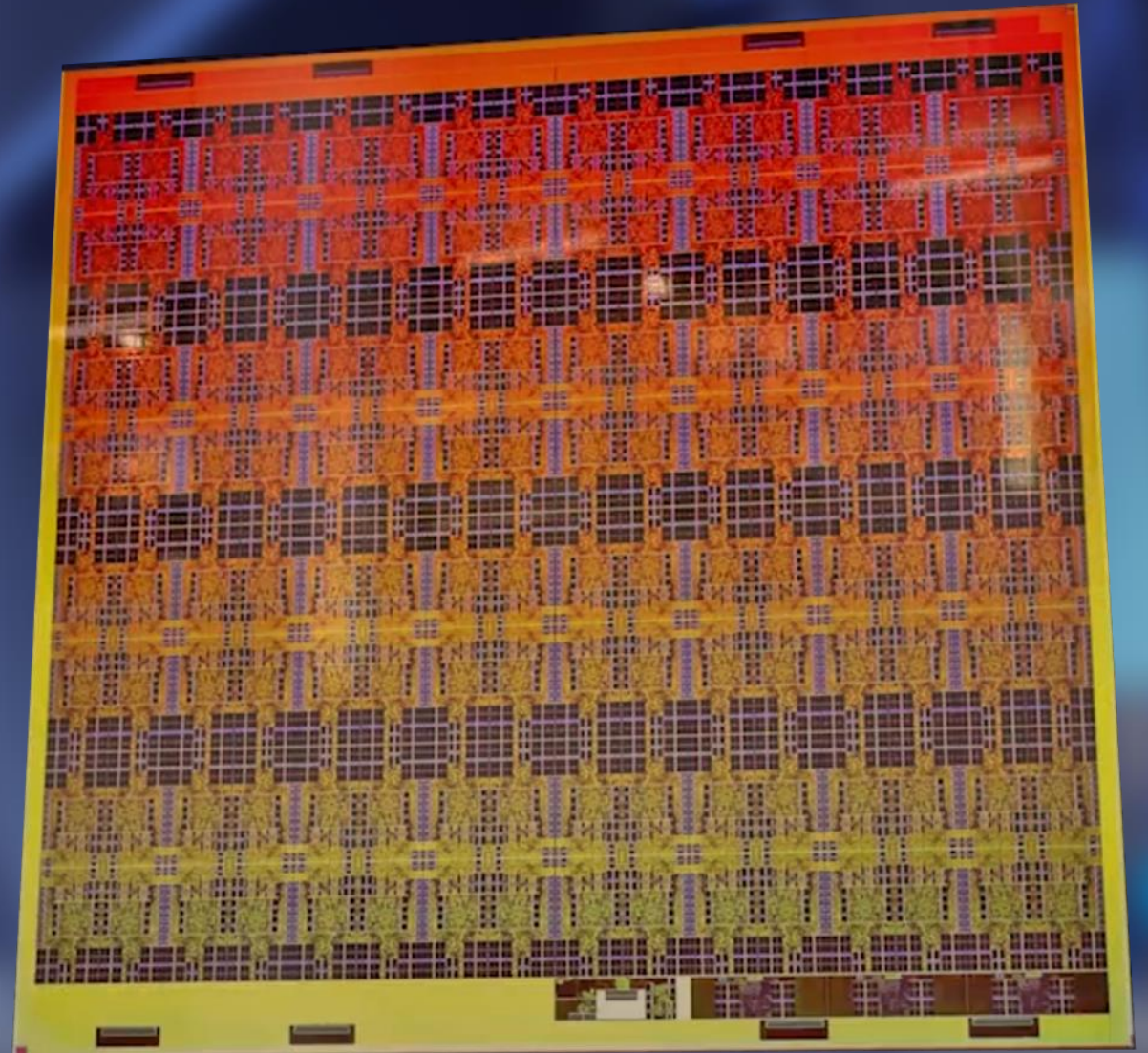

Loihi Efficiency

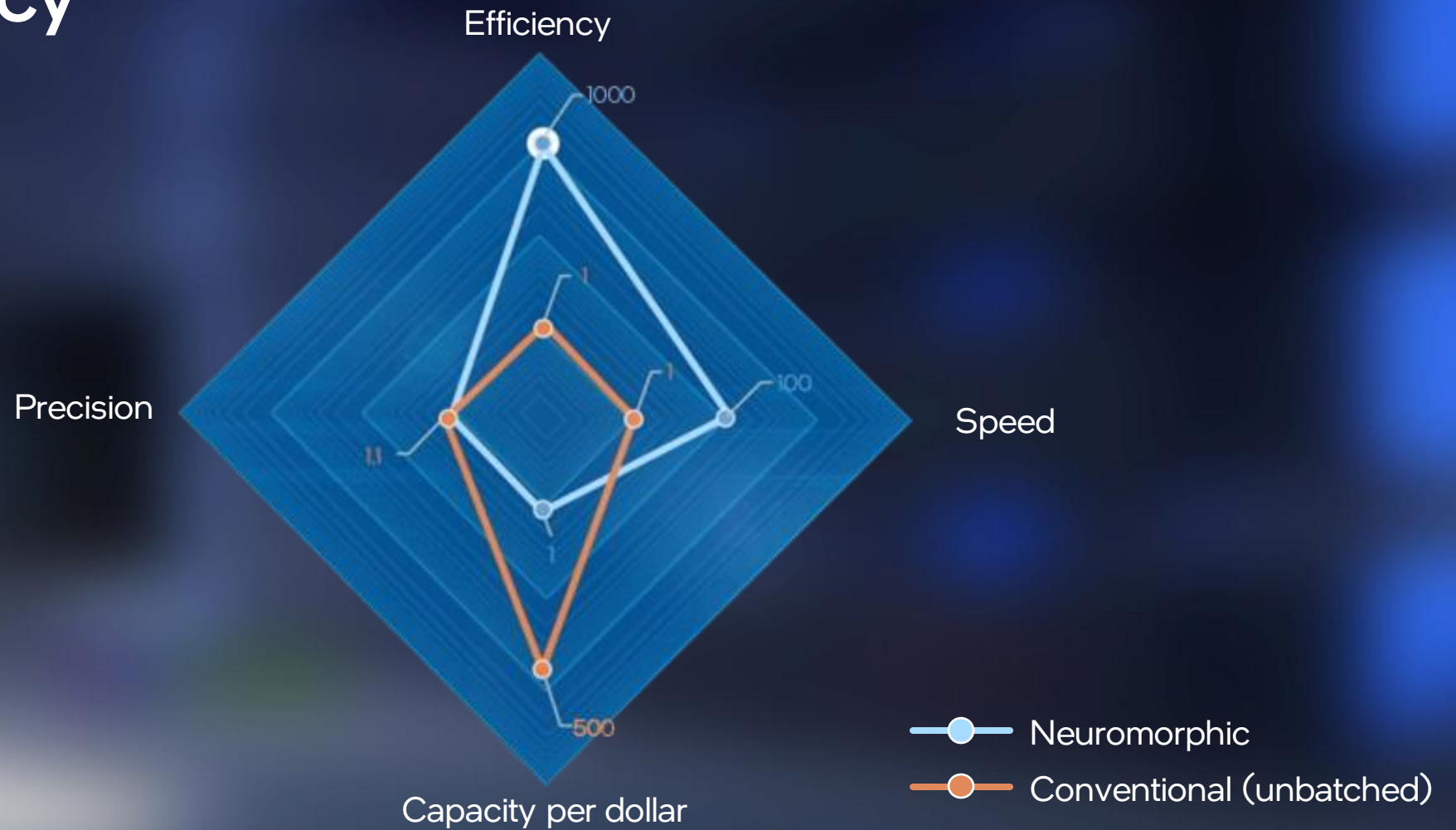



Pohoiki Springs



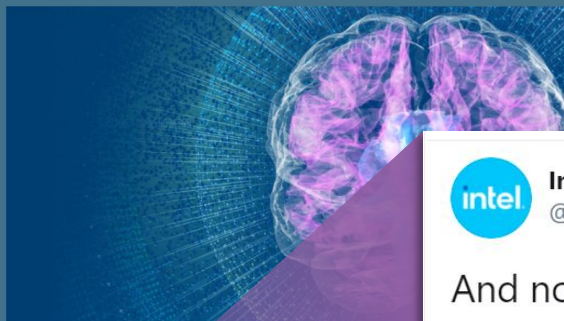

Beyond Today's AI

New algorithmic approaches emulate the human brain's interactions with the world.

Neuromorphic Computing Community Probabilistic Computing Resources

The emergent capabilities in artificial intelligence being driven by Intel Labs have more in common with human cognition than with conventional computer logic.

HIGHLIGHTS

- Neuromorphic computing research emulates the neural structure of the human brain.
- The Loihi research chip includes 130,000 neurons optimized for spiking neural networks.
- Intel Labs is making Loihi-based systems available to the global research community.
- Probabilistic computing addresses the fundamental uncertainty and noise of natural data.
- Collaborations on next-generation AI extend to worldwide industry and academic researchers.

What Is Neuromorphic Computing

The first generation of AI was rules-based and emulated classical logic to draw reasoned conclusions within a specific, narrowly defined problem domain. It was well suited to monitoring processes and improving efficiency, for example. The second, current generation is largely concerned with sensing and perception, such as using deep-learning networks to analyze the contents of a video frame.

A coming next generation will extend AI into areas that correspond to human cognition, such as interpretation and autonomous adaptation. This is critical to overcoming the so-called "brittleness" of AI solutions based on neural network training and inference, which depend on literal, deterministic views of events that lack context and commonsense understanding. Next-generation AI must be able to address novel situations and abstraction to automate ordinary human activities.

Intel Labs is driving computer-science research that contributes to this third generation of AI. Key focus areas include neuromorphic computing, which is concerned with emulating the neural structure and operation of the human brain, as well as probabilistic computing, which creates algorithmic approaches to dealing with the uncertainty, ambiguity, and contradictions of the natural world.

Neuromorphic Computing Research Focus

The key challenges in neuromorphic research are matching a human's flexibility, and ability to learn from unstructured stimuli with the energy efficiency of the human brain. The computational building blocks within neuromorphic computing systems are logically analogous to neurons. Spiking neural networks (SNNs) are a novel model for arranging those elements to emulate natural neural networks that exist in biological brains.



And now a conversation that will fire up everyone's neurons with Mike Davies, Director of Neuromorphic Computing at Intel Labs. Follow [#BehindTheBrains](#) to keep track and enjoy the thread

Join us on Twitter for a Q&A with

Mike Davies

intel.



11:00 AM · Sep 17, 2020 · Twitter Web App

News Byte

November 18, 2019

Contact Intel PR

Accenture, Airbus, GE and Hitachi Join Intel Neuromorphic Research Community



What's New: Today, Intel announced the first corporate members – Accenture, Airbus, GE and Hitachi – to join the fast-growing Intel Neuromorphic Research Community (INRC). The INRC has tripled in size over the past year and now has more than 75 organizations, spanning leading

Latest News: Artificial Intelligence



October 29, 2020

Intel to Acquire SigOpt to Scale AI Productivity and Performance



October 29, 2020

Artificial Intelligence



October 20, 2020

Intel Powers First Satellite with AI on Board

INRC includes
over 100 groups



Other names and brands may be claimed as the property of others

The
Future
Begins
Here

intel. labs

Opportunity at All Scales

Future
Neuromorphic
Technology



Visual Intelligence



Personalized Computing
(Real-time speech, speaker ID,
localization, denoising)



At-Scale Problem Solving
Data Analytics, Security, Scientific Computing

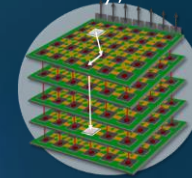

Intelligent Sensors
(Low latency, event-based,
anomaly detection)

IoT



Robotic Sensing + Control



SWaP-constrained AI
(Autonomous systems)



Human-Computer Interfacing
(EEG, neuroprosthetics)



Other names and brands may be claimed as the property of others

The
Future
Begins
Here

intel. labs

The Intel logo is displayed in white on a solid blue square background. It consists of the word "intel" in a lowercase, sans-serif font, with a small blue square above the letter "i". A registered trademark symbol (®) is located to the right of the word.The Accenture logo is displayed in black on a white square background. It features the word "accenture" in a lowercase, sans-serif font. A red chevron symbol (>) is positioned above the letter "t".

Other names and brands may be claimed as the property of others

The
Future
Begins
Here

intel. labs

News Byte

October 2, 2020

Contact Intel PR

Intel and Sandia National Labs Collaborate on Neuromorphic Computing

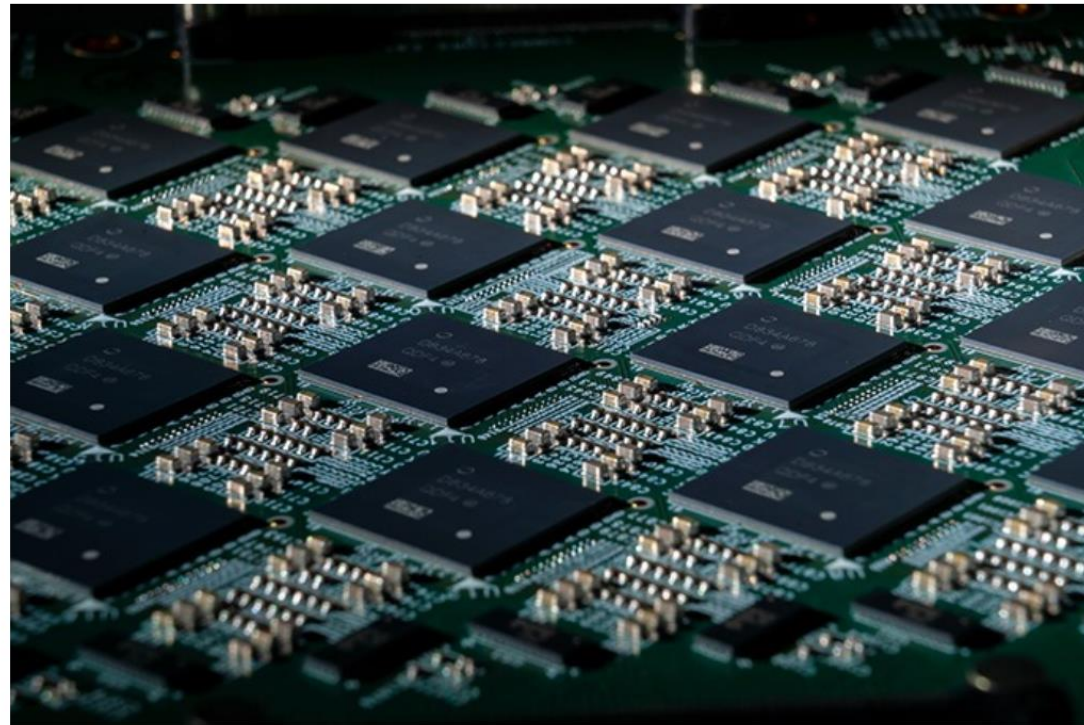

A close-up shot of an Intel Nahuku board, each of which contains 8 to 32 Intel Loihi neuromorphic chips. Intel's latest neuromorphic system, Pohoiki Beach, is made up of multiple Nahuku boards and contains 64 Loihi chips. Pohoiki Beach was introduced in July 2019. (Credit: Tim Herman/Intel Corporation)

Latest News: Artificial Intelligence

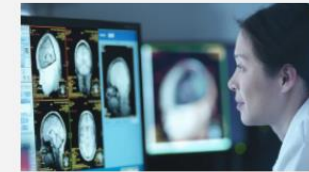

November 18, 2020
Survey Shows Next Era of Healthcare Will Be Powered by AI



November 17, 2020
First Intel Structured ASIC for 5G, AI, Cloud and Edge Announced



October 29, 2020
Intel to Acquire SigOpt to Scale AI Productivity and Performance

Read More

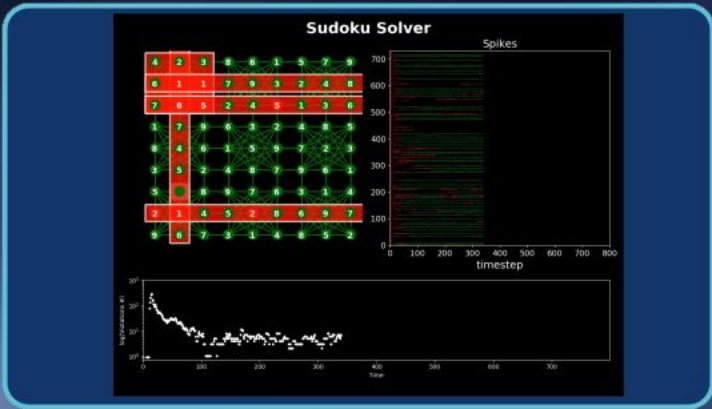

Constrained optimization problems
 (e.g. Sudoku)
 1000x lower energy
 100x faster

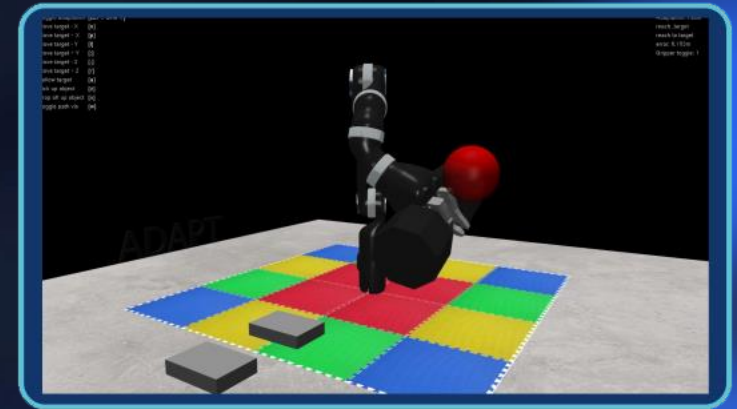

Adaptive robotic arm control 40x
 lower power , 50% faster (vs GPU)



Head direction localization and learning
 v00x lower power vs CPU
 1000x lower energy
 100x faster



Similarity search
 24x faster and 30x lower
 energy (vs CPU)



Visual-tactile sensing
 45x lower power
 20% faster (vs GPU)

The Intel logo, featuring the word "intel" in a white, lowercase, sans-serif font with a small blue square above the letter "i", set against a solid blue square background.

+

PROPHESĒĒ
METAVISION FOR MACHINES



Mercedes-Benz

logitech®

Lenovo™

Other names and brands may be claimed as the property of others

The
Future
Begins
Here

intel. labs

Quantum Computing

intel
labs

The
Future
Begins
Here

intel labs

Four biggest challenges to Quantum Practicality & How We Might Solve Them

Anne Matsuura

Director of Quantum Computing Architecture

Labs Day 2020

Changing the World

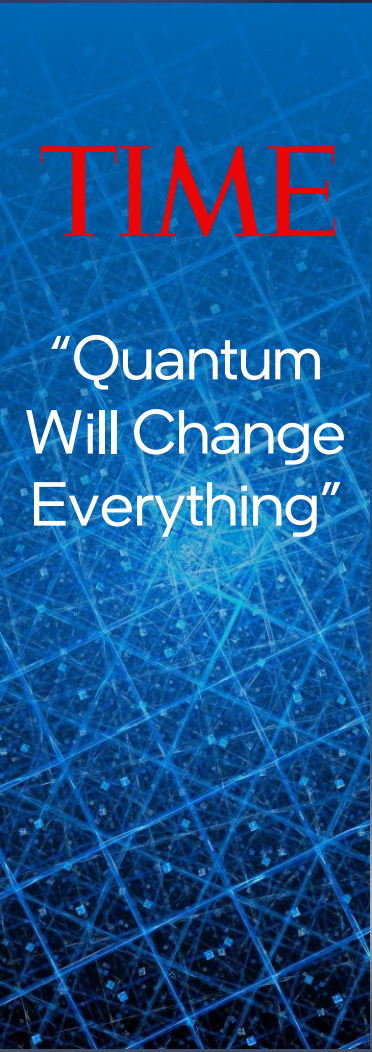

TIME

“Quantum Will Change Everything”



Climate Modeling



Travel & Logistics



Cryptography



Drug Design



Financial Modeling

Other names and brands may be claimed as the property of others

The Future Begins Here

intel. labs

Quantum Computing: Key Concepts

Superposition

Classical Physics



Heads OR Tails

Quantum Physics



Heads AND Tails

Entanglement



N Quantum Bits or Qubits = 2^N States

Fragility



Observation or noise
causes loss of information

Quantum Computing



- 1
- 2
- 3
- 4
- 5
- 6
- 7
- 8



Quantum Computing



Quantum Computing



Quantum Computing

Spin Qbit
technology

Cryogenic
control technology

Full stack innovation

A Quantum Bit

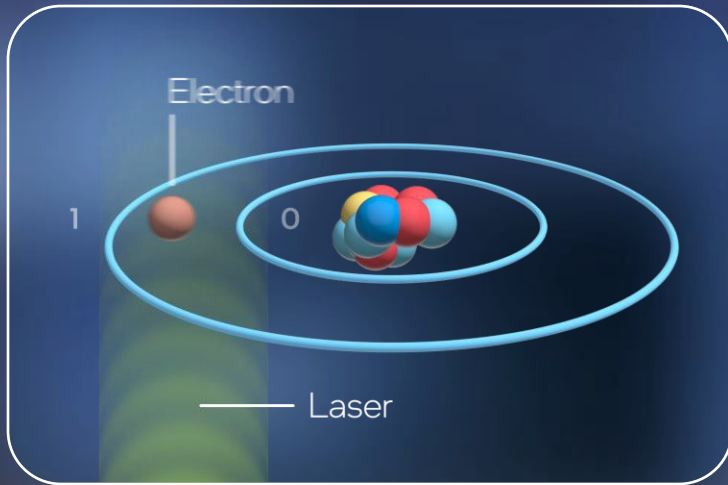

Honeywell,
IonQ

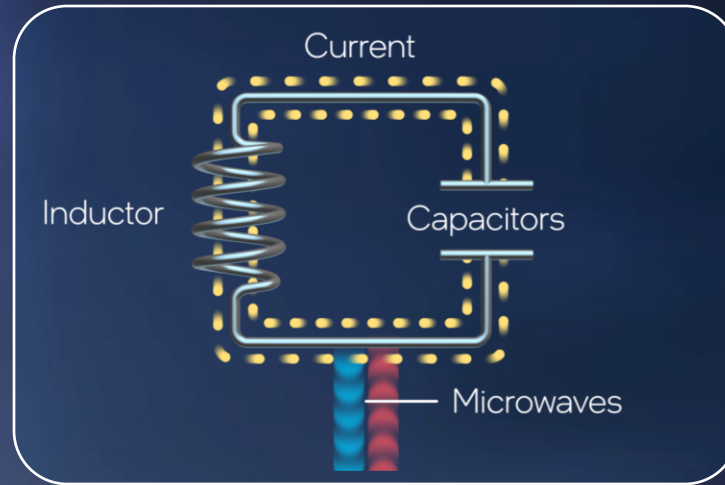

Intel Corporation,
HRL

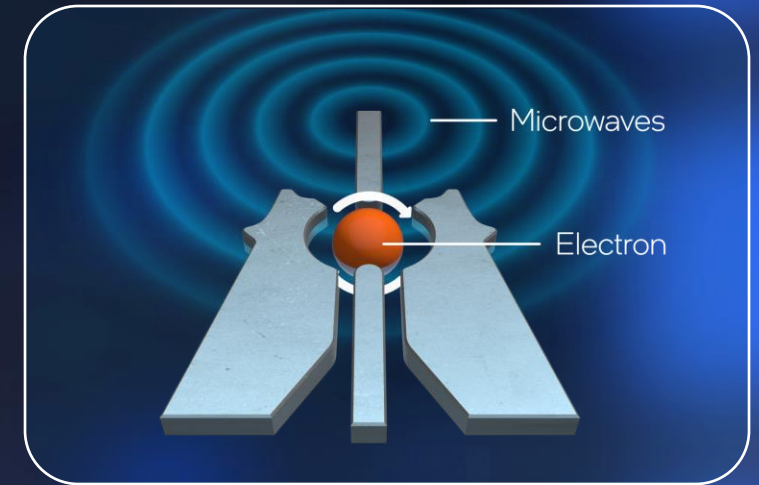

Google, IBM,
Rigetti, DWave

Only one of these Qubits is built on the technology of transistors

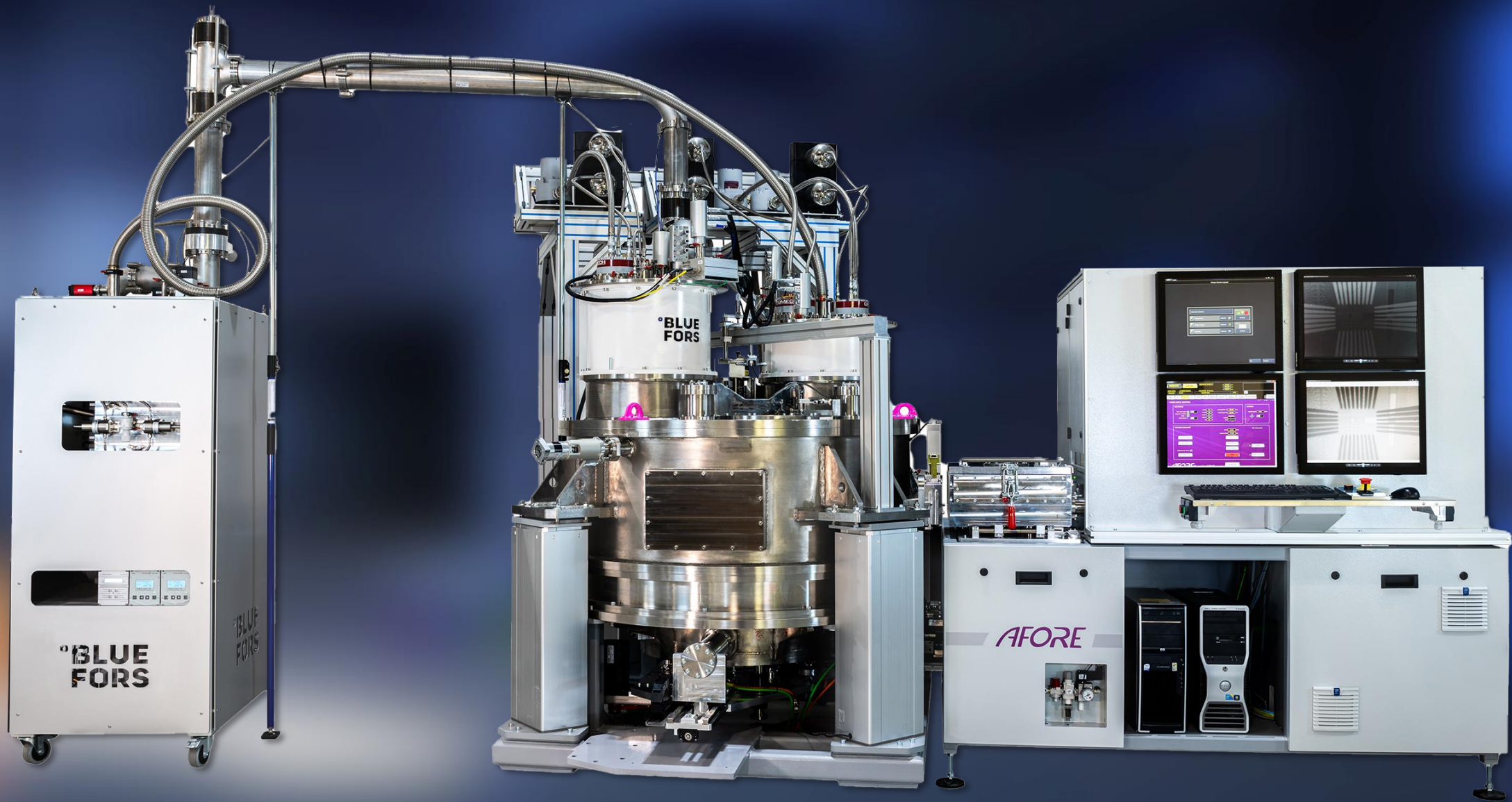

Other names and brands may be claimed as the property of others

The
Future
Begins
Here

intel. labs

Architecture: Completely New Kind of Compute

Quantum Algorithms

Quantum Compiler

Quantum Runtime

Qubit Control Processor

Control Electronics

Qubit Chip

Key system challenges for Quantum Practicality

- New execution model
- Error mitigation & resilience
- Scalability
- Interconnect complexity
- Qubit device design

Putting it All Together

Quantum Algorithms

Quantum Compiler

Quantum Runtime

Qubit Control Processor

Control Electronics

Qubit Chip

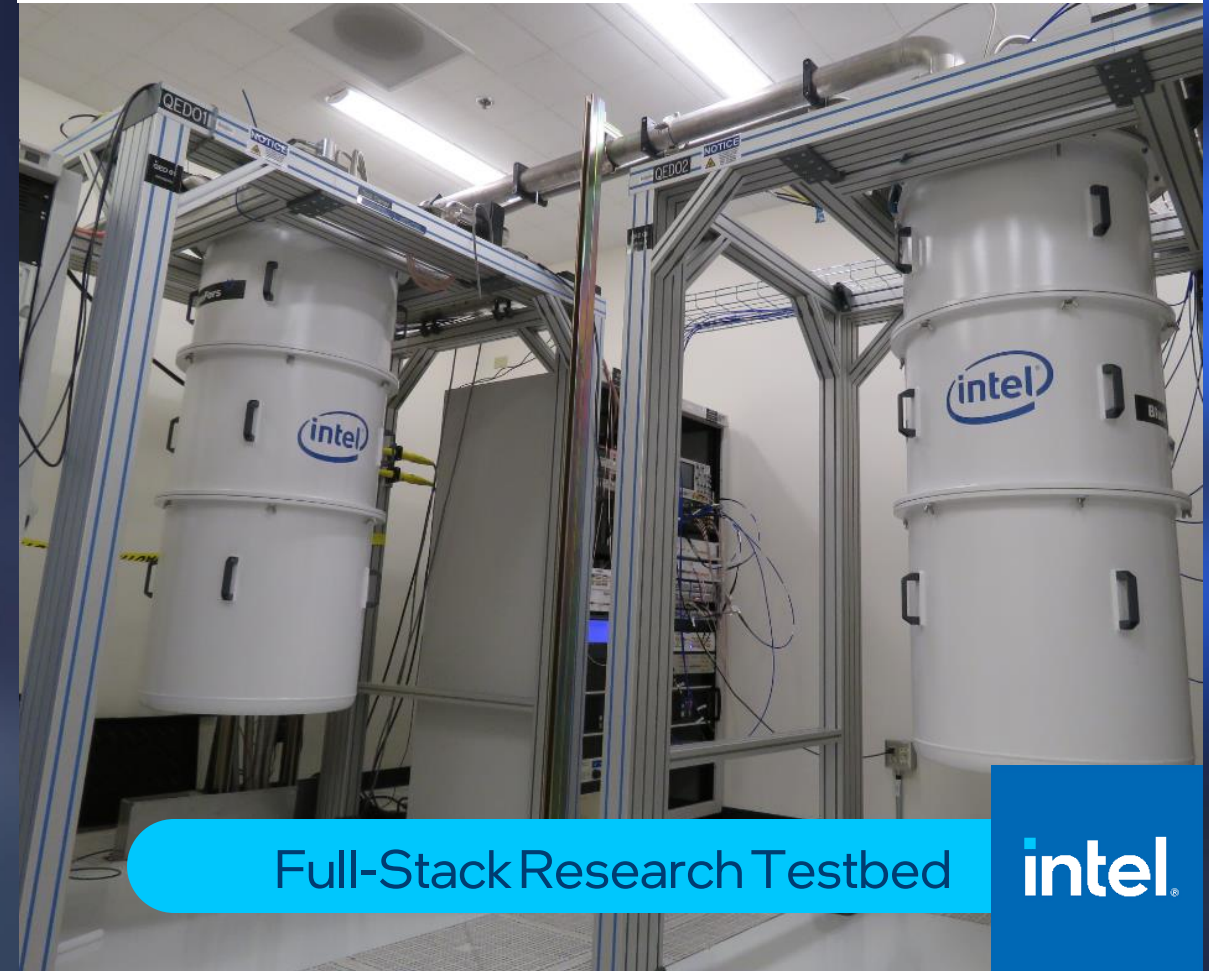

Full-Stack Research Testbed



*Q-NEXT brings together nearly 100 world-class researchers from three national laboratories, 10 universities and 10 leading U.S. technology companies with the single goal of developing the science and technology to control and distribute quantum information.

Confidential Computing

intel
labs

The Data Silo Problem

- Privacy / Legality
- Data too valuable
- Data too large to transmit

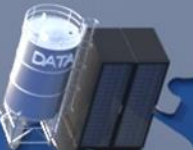

The
Future
Begins
Here

intel labs

Confidential Computing Edge to Cloud

Jason Martin

Principal Engineer, Security and Privacy Research

Labs Day 2020

Confidential Computing

Data Confidentiality
Execution Integrity
Attestation

Confidential Computing

Hardware Control
Access

Encryption

Federated Learning – Move Compute to Data

Centralized Learning

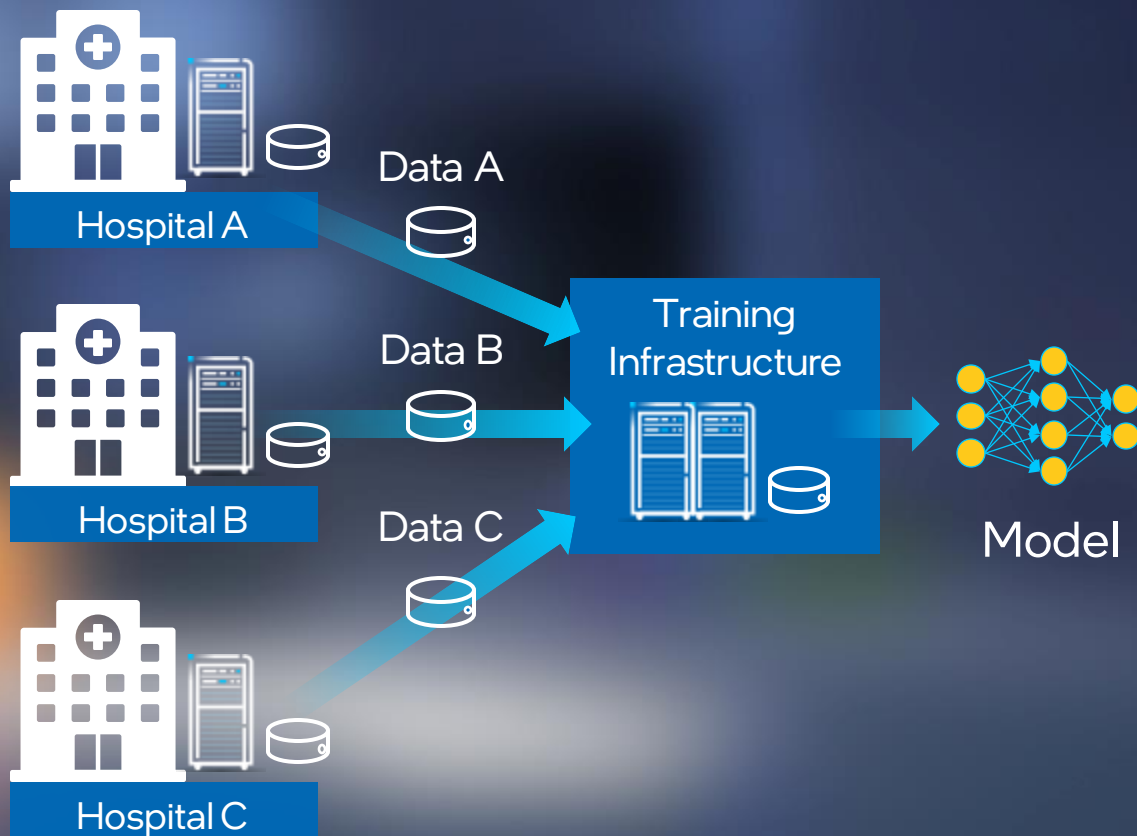

Federated Learning

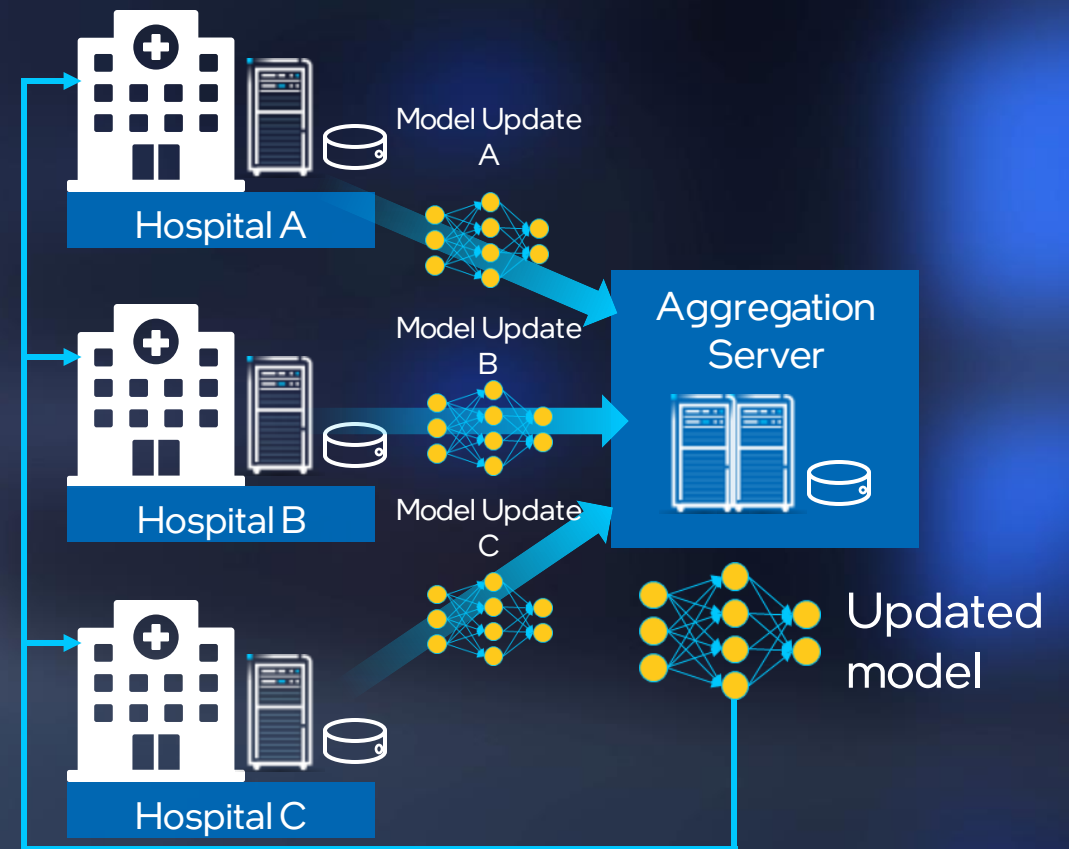

Intel-UPenn Collaboration



How much better does each institution do when training on the full data vs. just their own data?

17%
BETTER

on the hold-out BraTS data

2.6%
BETTER

on their own validation data

Brain tumor segmentation finds tumors from MRIs

Sheller, M.J., Edwards, B., Reina, G.A. *et al.* Federated learning in medicine: facilitating multi-institutional collaborations without sharing patient data. *Sci Rep*10, 12598 (2020).

Other names and brands may be claimed as the property of others



Fully
Homomorphic
Encryption



Traditional Encryption



Fully Homomorphic Encryption

10,000X

Larger

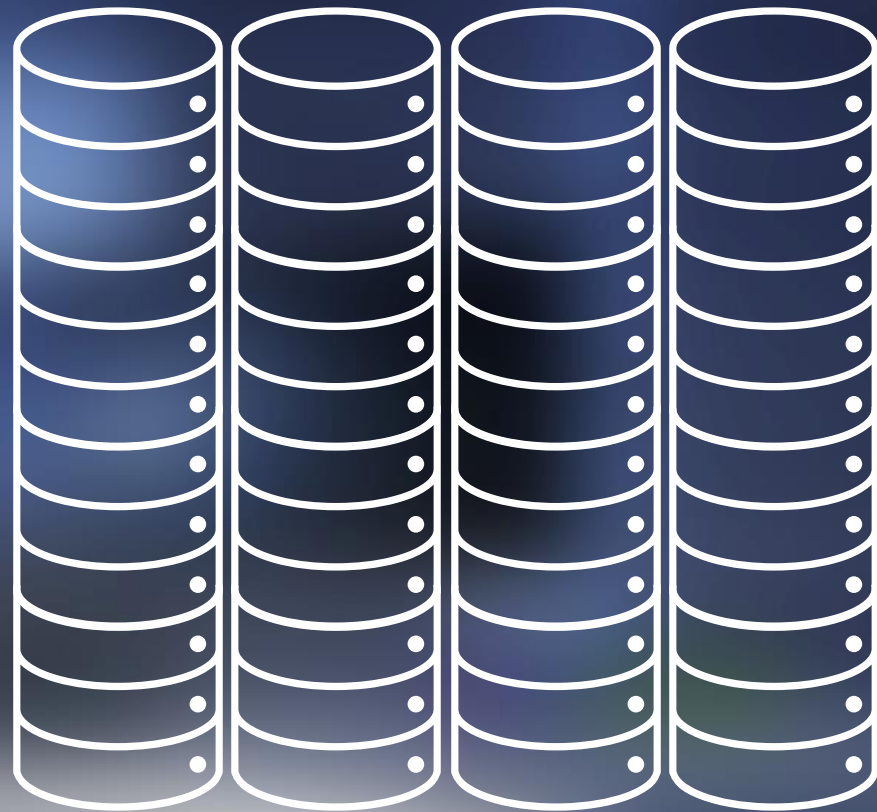

FHE Performance Explorations

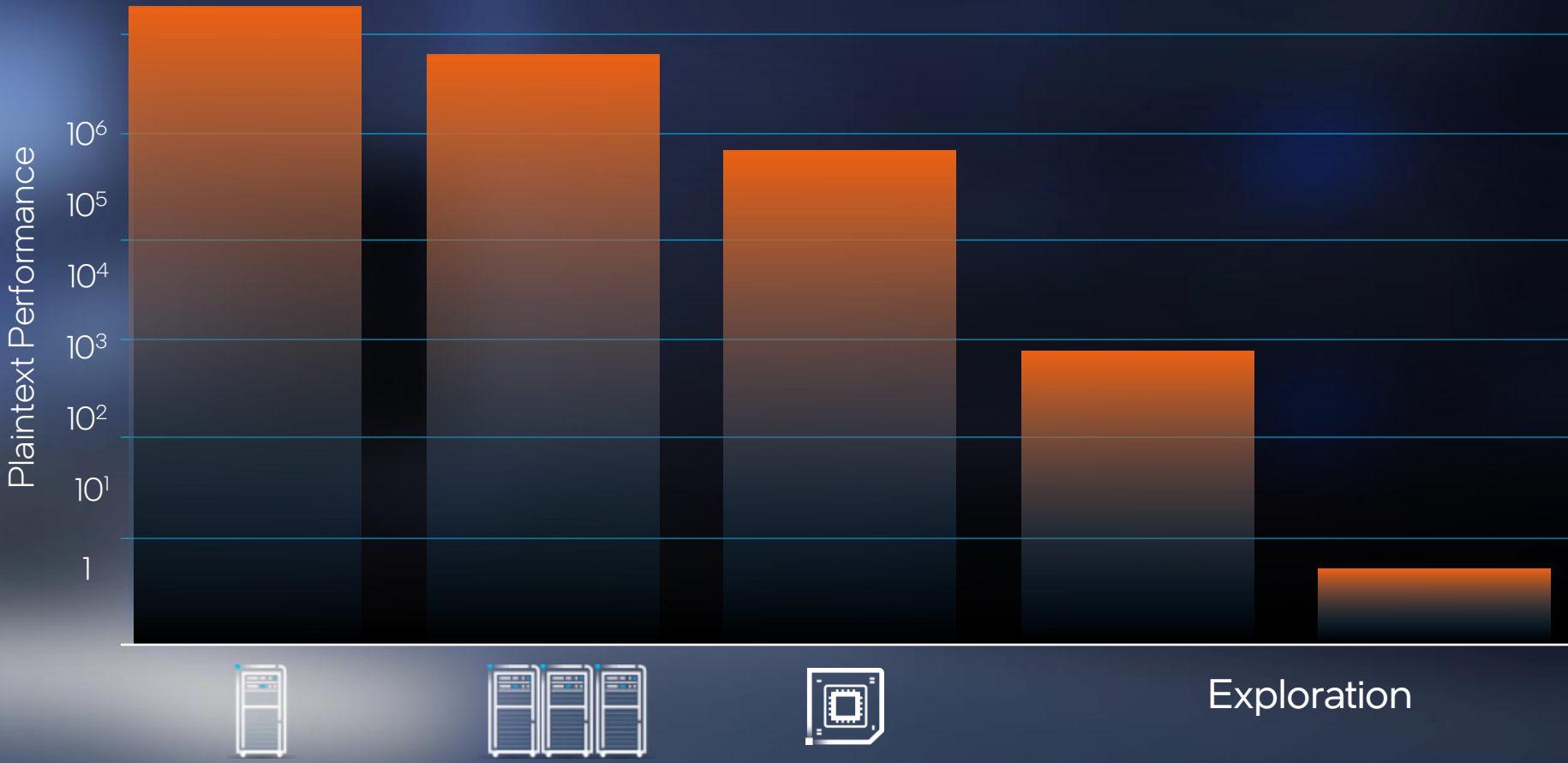

See cited sources for workloads and configurations. Results may vary.
Jung et al. [HEANN Demystified](#), arXiv:2003.04510, March 2020
Riazi et al. [HEAX](#), ASPLOS 2020

Intel Launches Private AI Collaborative Research Institute

Advancing technologies in privacy and trust for decentralized AI



Carnegie Mellon University
National University of Singapore
Université Catholique de Louvain
University of California, San Diego
University of Louvain
University of Southern California
University of Toronto
University of Waterloo
Technische Universität Darmstadt

Other names and brands may be claimed as the property of others

Machine Programming

intel
labs

Programming Challenges

Programming in the XPU Era

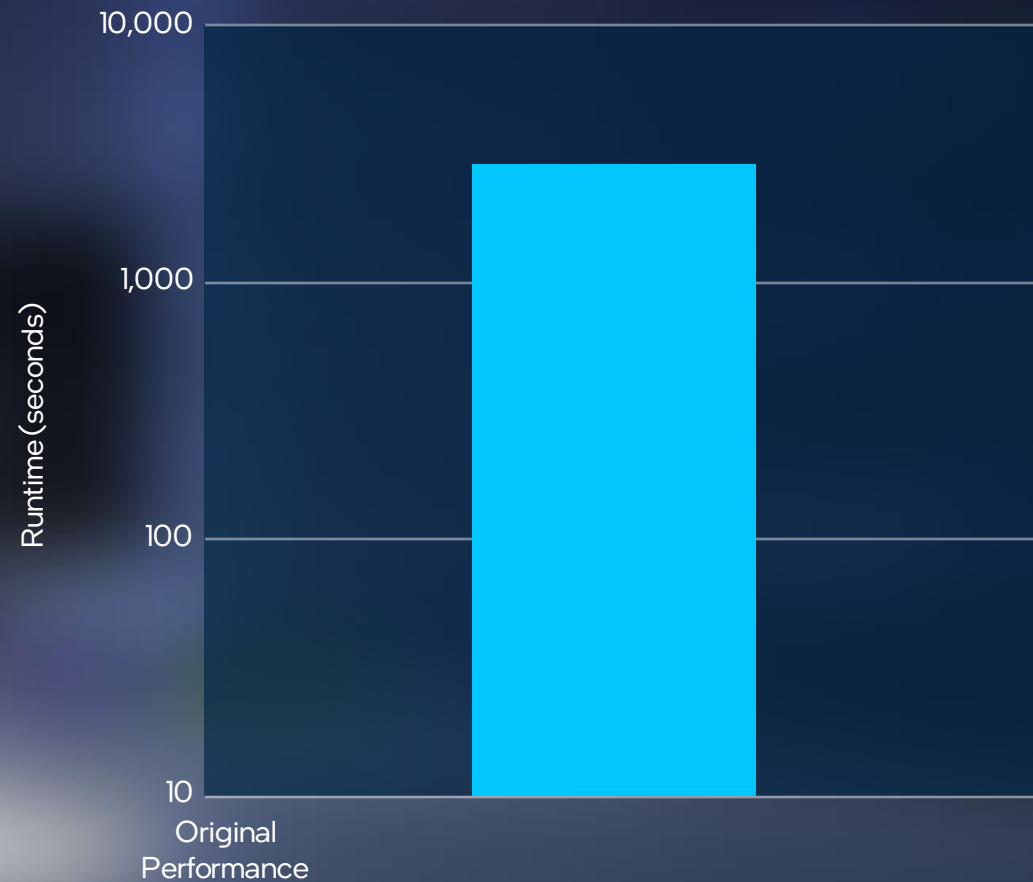

A cosmology application from the Stephen Hawking Institute

Source: Intel Labs

Ninja – an expert in SW development generally requiring a deep understanding of HW

Programming Challenges

Programming in the XPU Era



A cosmology application from the Stephen Hawking Institute

Source: Intel Labs

Ninja – an expert in SW development generally requiring a deep understanding of HW

Programming Challenges

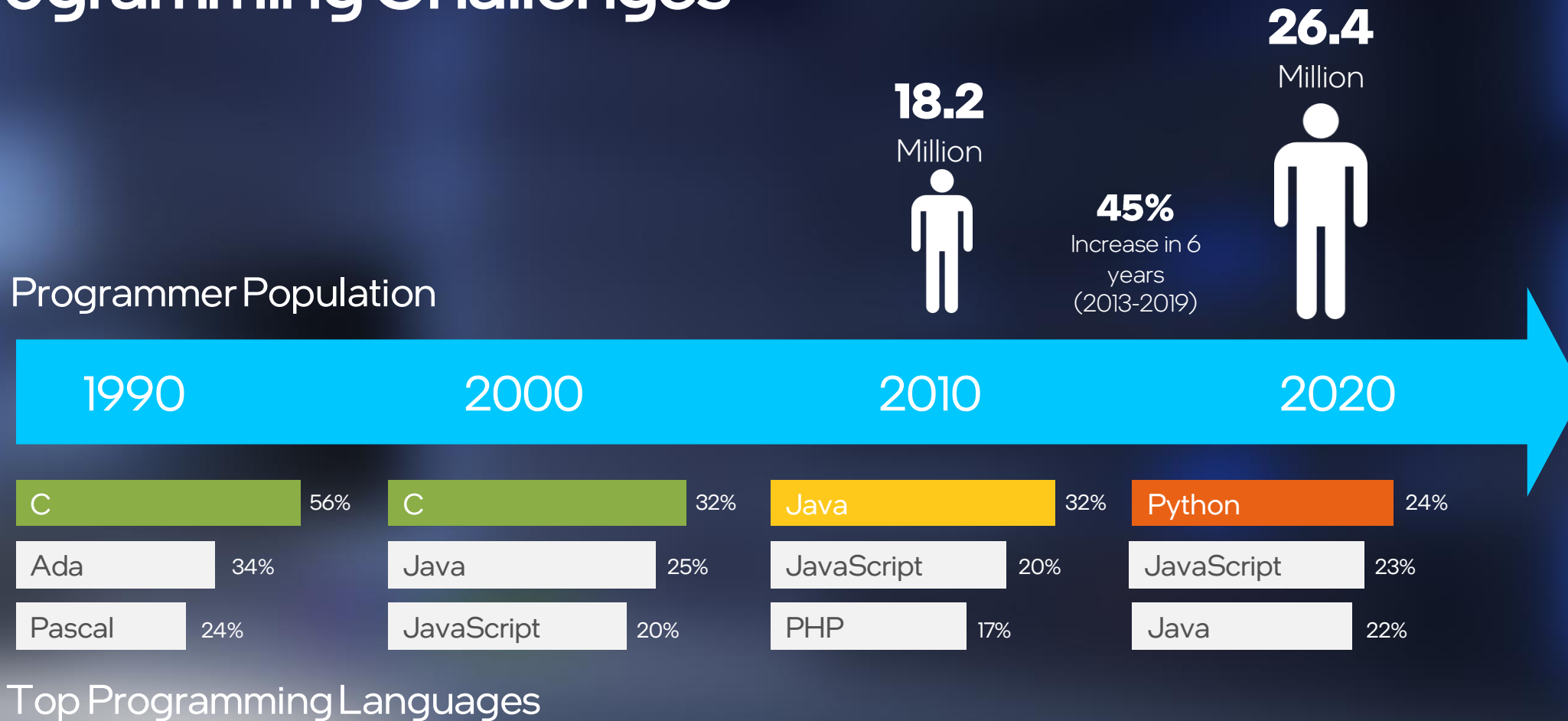

Other names and brands may be claimed as the property of others
Source – Programming Languages: <https://youtu.be/Og847HVwRSJ>, <http://pypl.github.io/PYPL.html>
Source – Programmer Population size: <http://www.computersciencezone.org/developers>

The
Future
Begins
Here

intel labs

Reimagining the Future of AI-assisted Software Design

Justin Gottschlich

Principal Engineer, Machine Programming Research

Labs Day 2020

How do you develop software to fully exercise the capabilities of these novel types of hardware?



Machine Programming

- Any technique that automates software development

Intel's goal with MP

- Democratize and accelerate the creation of quality software

The Three Pillars of Machine Programming

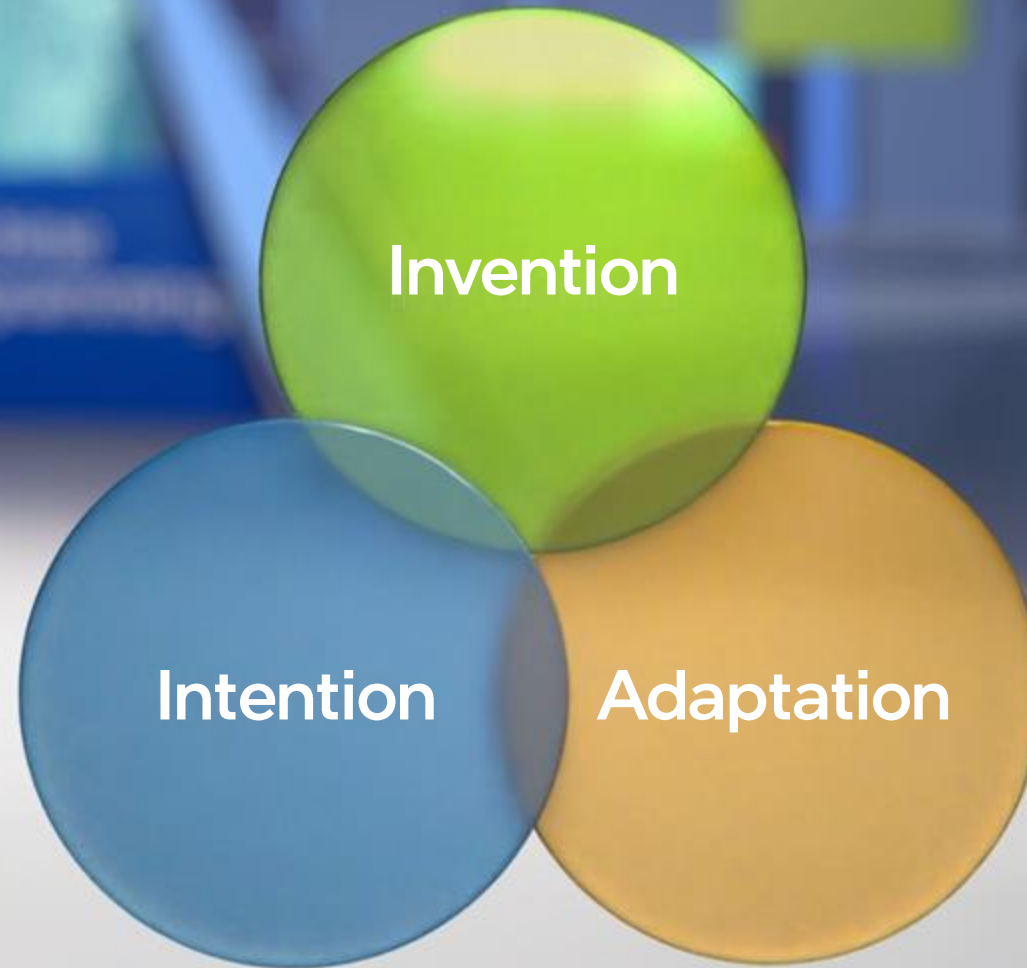



Less than 1% of the global
population can code.

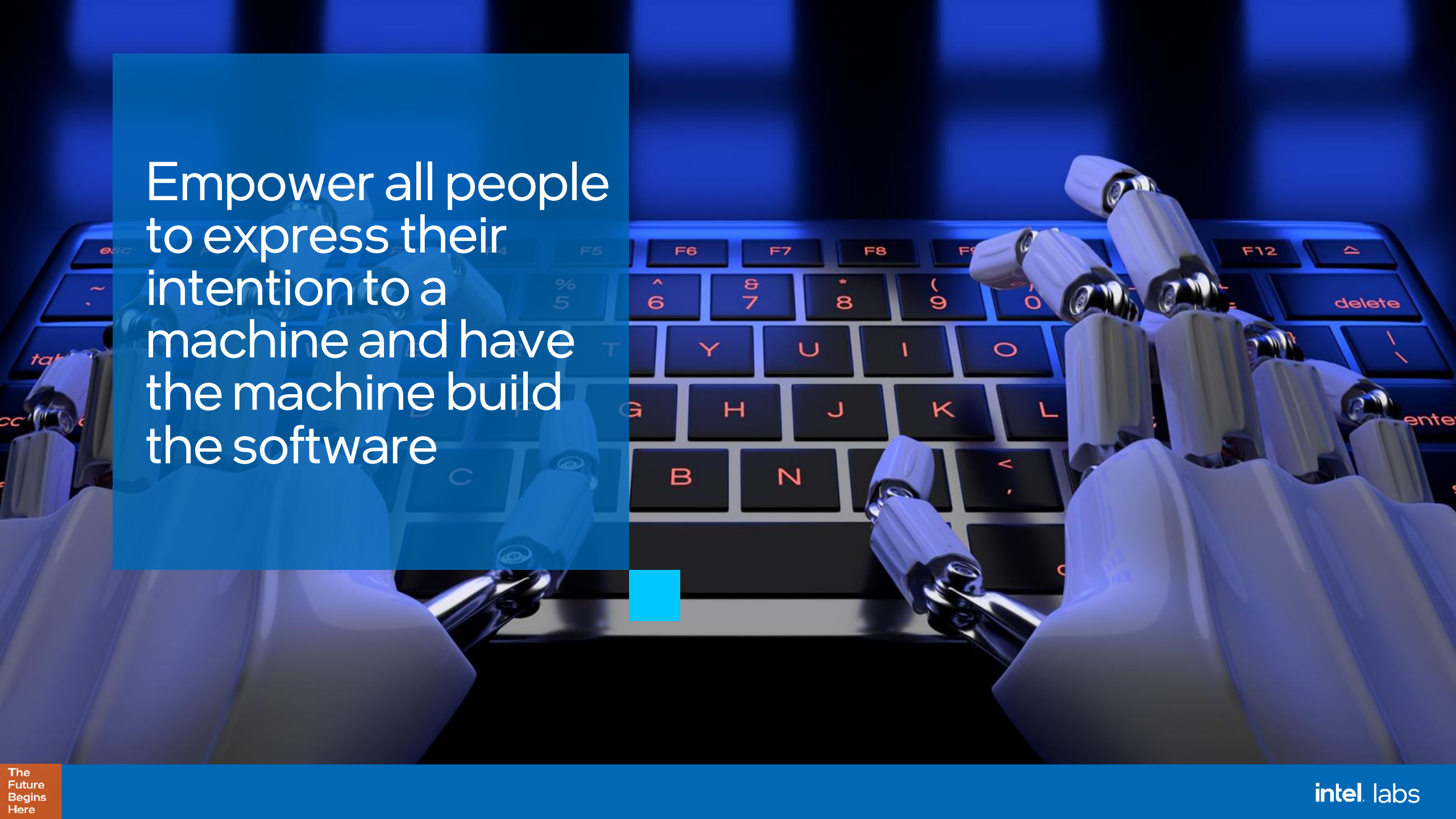

Empower all people
to express their
intention to a
machine and have
the machine build
the software



Programmers spend
50% of their time debugging

Can we do better?

Legal Information

Performance varies by use, configuration and other factors. Learn more at www.Intel.com/PerformanceIndex.

Performance results are based on testing as of dates shown in configurations and may not reflect all publicly available updates. See backup for configuration details. No product or component can be absolutely secure.

Your costs and results may vary.

Results have been estimated or simulated.

Intel technologies may require enabled hardware, software or service activation.

Intel does not control or audit third-party data. You should consult other sources to evaluate accuracy.

Intel disclaims all express and implied warranties, including without limitation, the implied warranties of merchantability, fitness for a particular purpose, and non-infringement, as well as any warranty arising from course of performance, course of dealing, or usage in trade.

© Intel Corporation. Intel, the Intel logo, and other Intel marks are trademarks of Intel Corporation or its subsidiaries. Other names and brands may be claimed as the property of others.

A person stands on a rocky shore, looking out at the ocean under a night sky with the aurora borealis. The scene is dark and atmospheric, with the aurora displaying vibrant green and purple hues. The person is silhouetted against the bright light of the aurora. The ocean is visible in the distance, with waves breaking on the shore. The overall mood is contemplative and futuristic.

The Future Begins Here

intel® labs

Labs Day 2020 | December 3